

SISTEMA ESTRUTURAL DE REVESTIMENTO

Catálogo Técnico

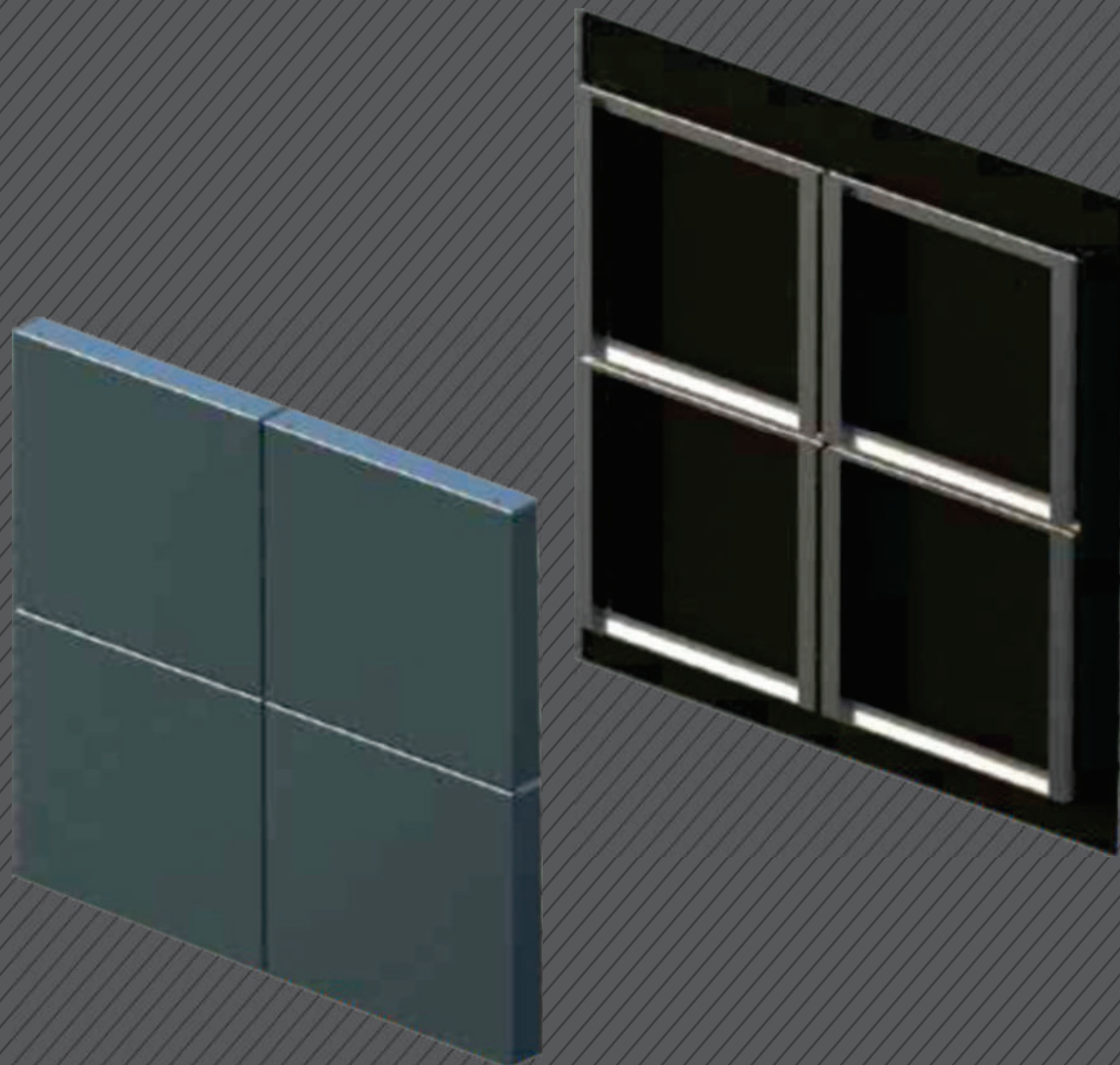

01 PERFIS SISTEMA DE REVESTIMENTO**NOTAS IMPORTANTES:**

- Fornecimento dos Perfis em Barra de 6000mm.
- Para as dimensões fora destes padrões o lote mínimo por item é de 150 Kg.
- Perfis e Acessórios, sujeito a alterações sem prévio aviso.

Rev. 01/21

ÍNDICE DE PERFIS

| CÓDIGO | DESCRIÇÃO | PÁGINA |
|---------------|---------------------------|---------------|
| MC-004 | Tampa | 03 |
| MC-005 | Gancho | 03 |
| MC-007 | Coluna Principal | 03 |
| MC-008 | Montante Superior Bandeja | 04 |
| MC-009 | Montante Inferior Bandeja | 04 |
| MC-010 | Presilha Regulável | 03 |
| | | |

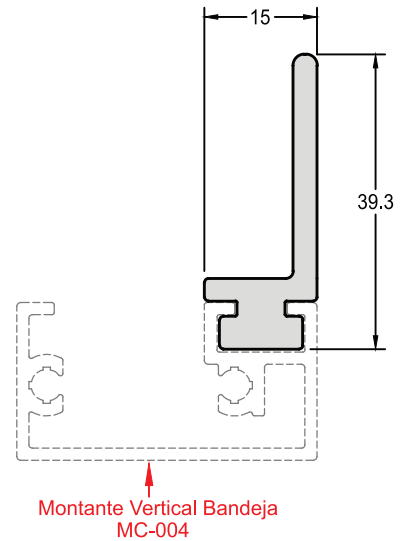
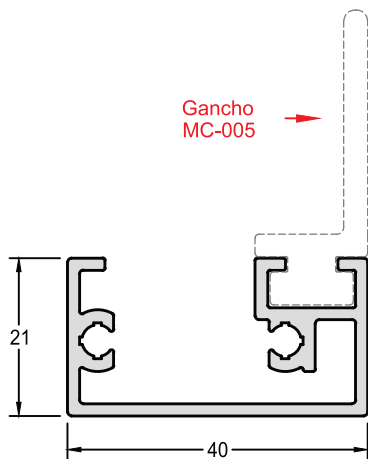

| MC-004 | Montante Vertical Bandeja | | | |
|--------|---------------------------|---|--------|---|
| | Peso (Kg/m) | Superfície (mm ² /mml) Área Perímetro | | Inércia (mm ² /mml) Jx mm ⁴ Jy mm ⁴ |
| | 0,590 | 217.72 | 257.34 | 26170.52 3177.97 |

| MC-005 | Gancho | | | |
|--------|-------------|---|--------|---|
| | Peso (Kg/m) | Superfície (mm ² /mml) Área Perímetro | | Inércia (mm ² /mml) Jx mm ⁴ Jy mm ⁴ |
| | 0,544 | 200.67 | 114.43 | 26170.52 3177.97 |

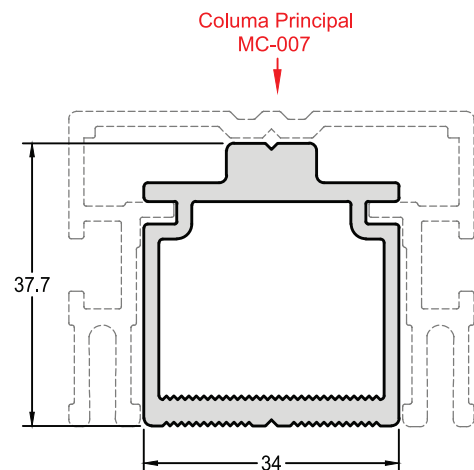
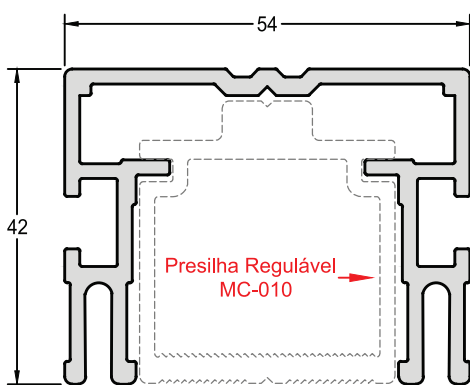

| MC-007 | Coluna Principal | | | |
|--------|------------------|---|--------|---|
| | Peso (Kg/m) | Superfície (mm ² /mml) Área Perímetro | | Inércia (mm ² /mml) Jx mm ⁴ Jy mm ⁴ |
| | 1,231 | 454.28 | 420.85 | 85305.66 194711.17 |

| MC-010 | Presilha Regulável | | | |
|--------|--------------------|---|--------|---|
| | Peso (Kg/m) | Superfície (mm ² /mml) Área Perímetro | | Inércia (mm ² /mml) Jx mm ⁴ Jy mm ⁴ |
| | 1,052 | 388.19 | 289.60 | 70829.86 48586.45 |

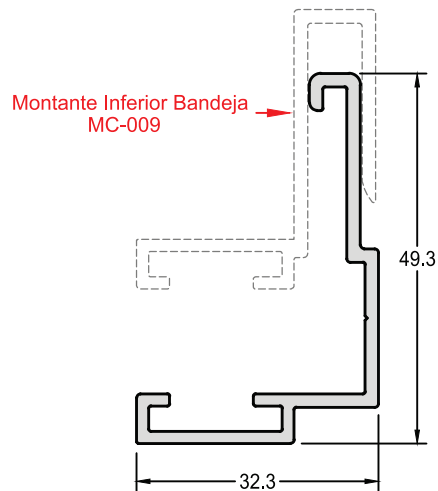

| MC-008 | Montante Superior Bandeja | | | | |
|--------|---------------------------|-----------------------------------|-----------|--------------------------------|--------------------|
| | Peso (Kg/m) | Superfície (mm ² /mml) | | Inércia (mm ² /mml) | |
| | | Área | Perímetro | Jx mm ⁴ | Jy mm ⁴ |
| | 0,474 | 174.94 | 202.89 | 48860.21 | 17039.98 |

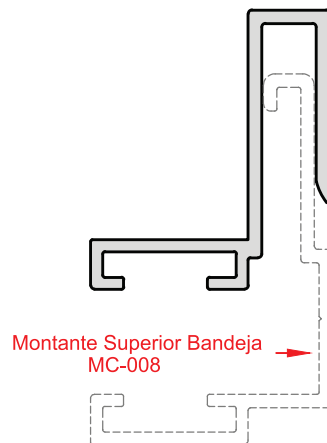

| MC-009 | Montante Inferior Bandeja | | | | |
|--------|---------------------------|-----------------------------------|-----------|--------------------------------|--------------------|
| | Peso (Kg/m) | Superfície (mm ² /mml) | | Inércia (mm ² /mml) | |
| | | Área | Perímetro | Jx mm ⁴ | Jy mm ⁴ |
| | 0,480 | 177.30 | 205.40 | 26496.61 | 14691.22 |